



Hydraulic Hinge Concealed Door Hinge





Hydraulic Hinge

Automatic buffer door closing
Bring you safty and a quiet ambience

Material: Aluminum alloy

Thickness: 3mm

Finish:  black  grey  gold  silver



Functional Diagram

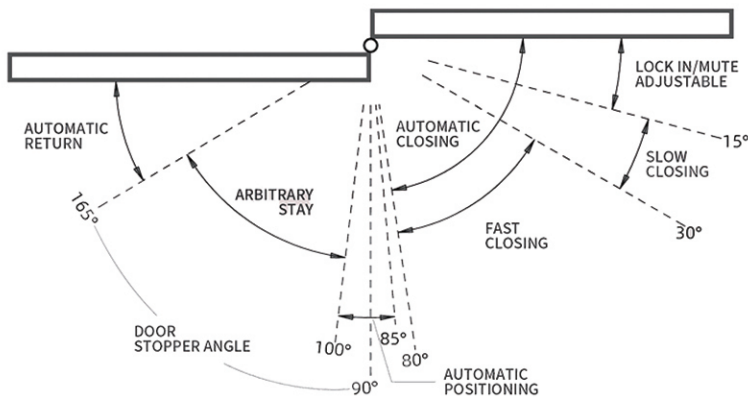

1. Max. opening angle 175°
2. Stay open between 90°-165°
3. Positioning function 90°, when the door is 85°-95° will be reset to 90°
4. Door close automatically < 80°
5. Three closing speed
 - (1) Fast closing 80°-30°
 - (2) Slow closing 30°-15°
 - (3) Latching 15°-0°

Buffer Adjustment

to increase or decrease closing speed.



Selection

selection between the door with without the latch.

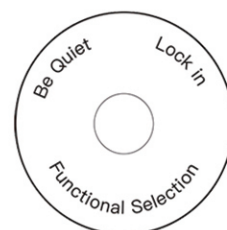



D535 D-Type Hydraulic Hinge



Dimensions 5.5"

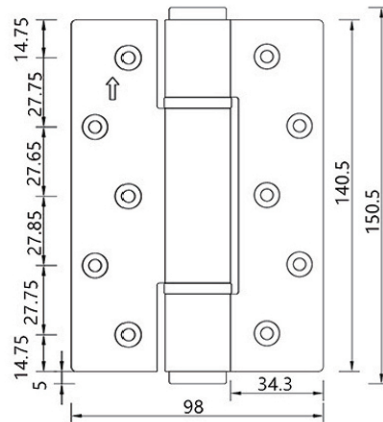

Specification

Door Weight	Door Size	Hinges	Remarks
≤35kgs	≤2000x700mm	hydraulic hinge x1 ball bearing hinge x1	better performance using hydraulic hinge x2
≤60kgs	≤2000x900mm	hydraulic hinge x2	door height over 2100mm, add a ball bearing hinge in the middle.
≤90kgs	≤2400x1100mm	hydraulic hinge x3	



D530 D-Type Hydraulic Hinge

(30mm wide for narrow door frame)



Dimensions 5.5"

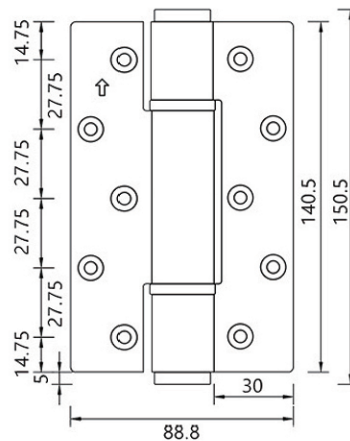

Specification

Door Weight	Door Size	Hinges	Remarks
≤35kgs	≤2000x700mm	hydraulic hinge x1 ball bearing hinge x1	better performance using hydraulic hinge x2
≤60kgs	≤2000x900mm	hydraulic hinge x2	door height over 2100mm, add a ball bearing hinge in the middle.
≤90kgs	≤2400x1100mm	hydraulic hinge x3	



D635 D-Type Hydraulic Hinge



Dimensions 6"

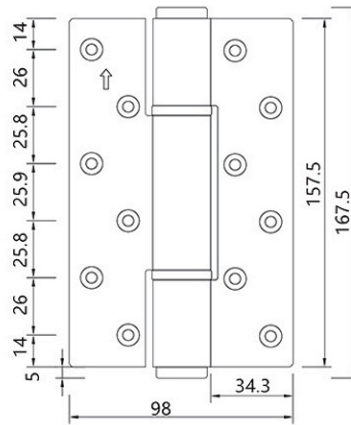

Specification

Door Weight	Door Size	Hinges	Remarks
≤50kgs	≤2000x700mm	hydraulic hinge x1 ball bearing hinge x1	better performance using hydraulic hinge x2
≤90kgs	≤2000x900mm	hydraulic hinge x2	door height over 2100mm, add a ball bearing hinge in the middle.
≤135kgs	≤2400x1100mm	hydraulic hinge x3	



D630 D-Type Hydraulic Hinge

(30mm wide for narrow door frame)



Dimensions 6"

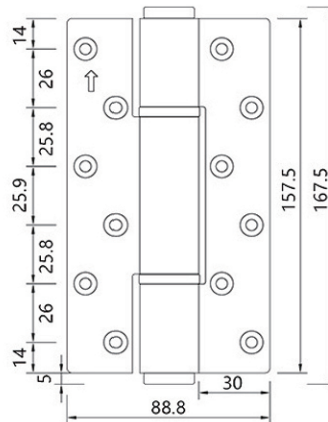

Specification

Door Weight	Door Size	Hinges	Remarks
≤50kgs	≤2000x700mm	hydraulic hinge x1 ball bearing hinge x1	better performance using hydraulic hinge x2
≤90kgs	≤2000x900mm	hydraulic hinge x2	door height over 2100mm, add a ball bearing hinge in the middle.
≤135kgs	≤2400x1100mm	hydraulic hinge x3	

M535 Sub-Parent Hydraulic Hinge



Dimensions 5.5"

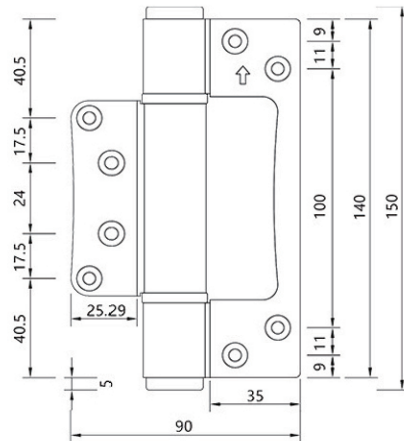

Specification

Door Weight	Door Size	Hinges	Remarks
≤35kgs	≤2000x700mm	hydraulic hinge x1 ball bearing hinge x1	better performance using hydraulic hinge x2
≤60kgs	≤2000x900mm	hydraulic hinge x2	door height over 2100mm, add a ball bearing hinge in the middle.
≤90kgs	≤2400x1100mm	hydraulic hinge x3	

F535 Flag-Type Hydraulic Hinge



Determine Direction

Check the hinge open direction matches with the door.

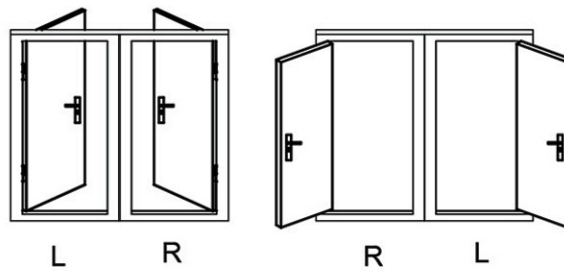

Dimensions 5.5"

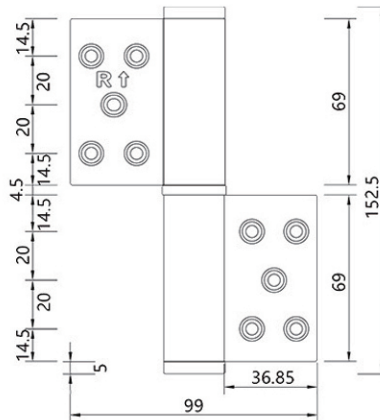

Specification

Door Weight	Door Size	Hinges	Remarks
≤35kgs	≤2000x700mm	hydraulic hinge x1 ball bearing hinge x1	better performance using hydraulic hinge x2
≤60kgs	≤2000x900mm	hydraulic hinge x2	door height over 2100mm, add a ball bearing hinge in the middle.
≤90kgs	≤2400x1100mm	hydraulic hinge x3	



F530 Flag-Type Hydraulic Hinge

(30mm wide for narrow door frame)



Determine Direction

Check the hinge open direction matches with the door.

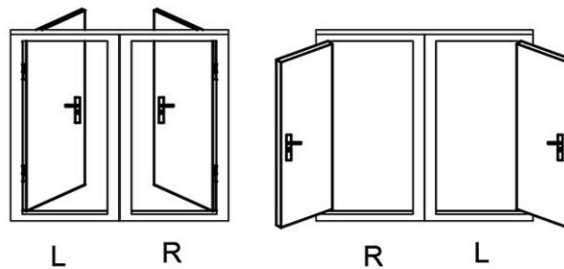

Dimensions 5.5"

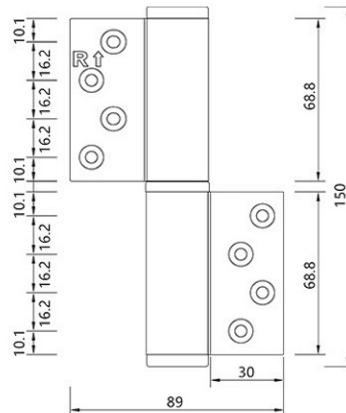

Specification

Door Weight	Door Size	Hinges	Remarks
≤35kgs	≤2000x700mm	hydraulic hinge x1 ball bearing hinge x1	better performance using hydraulic hinge x2
≤60kgs	≤2000x900mm	hydraulic hinge x2	door height over 2100mm, add a ball bearing hinge in the middle.
≤90kgs	≤2400x1100mm	hydraulic hinge x3	

F535P Flag-Type Hydraulic Hinge (surface mounting)



Determine Direction

Check the hinge open direction matches with the door.

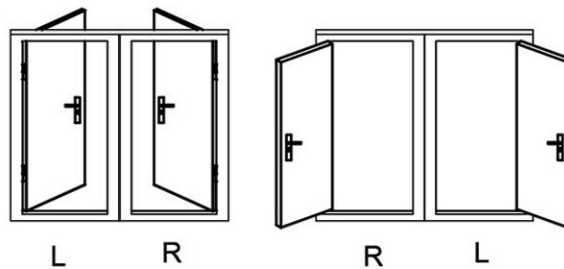

Dimensions 5.5"

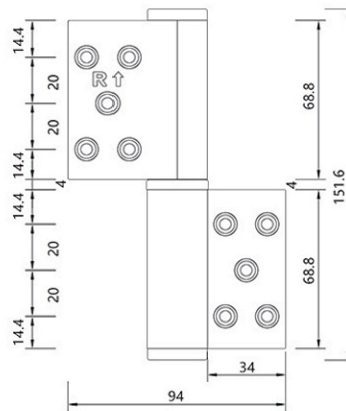

Specification

Door Weight	Door Size	Hinges	Remarks
≤35kgs	≤2000x700mm	hydraulic hinge x1 ball bearing hinge x1	better performance using hydraulic hinge x2
≤60kgs	≤2000x900mm	hydraulic hinge x2	door height over 2100mm, add a ball bearing hinge in the middle.
≤90kgs	≤2400x1100mm	hydraulic hinge x3	

F635 Flag-Type Hydraulic Hinge



Determine Direction

Check the hinge open direction matches with the door.

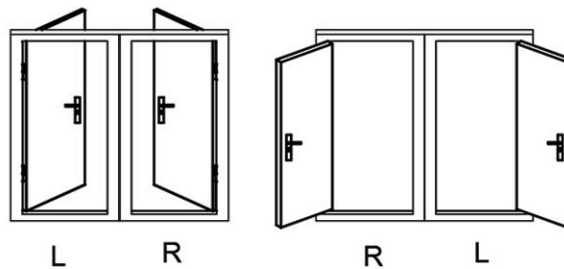

Dimensions 6"

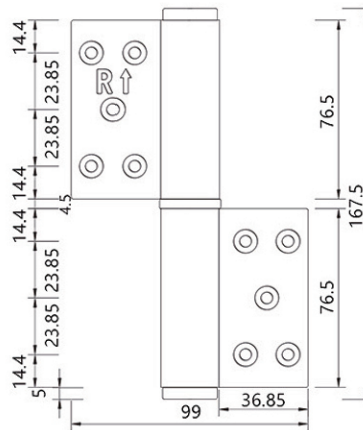

Specification

Door Weight	Door Size	Hinges	Remarks
≤50kgs	≤2000x700mm	hydraulic hinge x1 ball bearing hinge x1	better performance using hydraulic hinge x2
≤90kgs	≤2000x900mm	hydraulic hinge x2	door height over 2100mm, add a ball bearing hinge in the middle.
≤135kgs	≤2400x1100mm	hydraulic hinge x3	

F635P Flag-Type Hydraulic Hinge (surface mounting)



Determine Direction

Check the hinge open direction matches with the door.

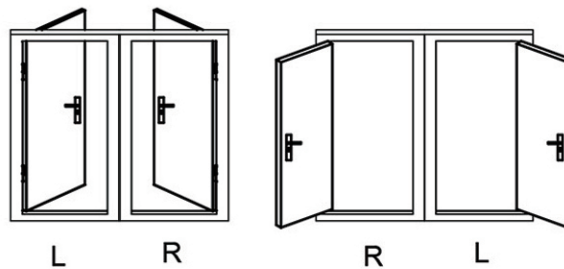

Dimensions 6"

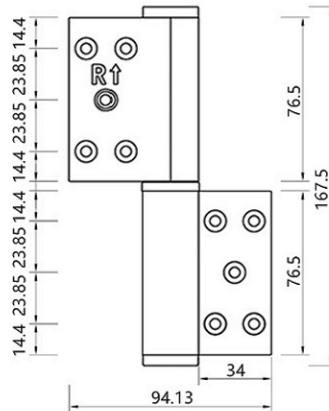

Specification

Door Weight	Door Size	Hinges	Remarks
≤50kgs	≤2000x700mm	hydraulic hinge x1 ball bearing hinge x1	better performance using hydraulic hinge x2
≤90kgs	≤2000x900mm	hydraulic hinge x2	door height over 2100mm, add a ball bearing hinge in the middle.
≤135kgs	≤2400x1100mm	hydraulic hinge x3	

F530S Offset Hydraulic Hinge



Determine Direction

Check the hinge open direction matches with the door.

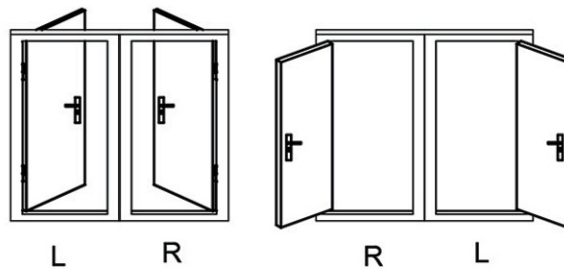

Dimensions 5.5"

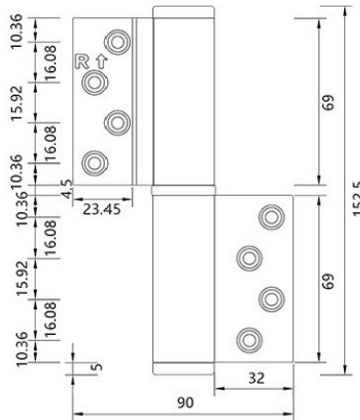

Specification

Door Weight	Door Size	Hinges	Remarks
≤35kgs	≤2000x700mm	hydraulic hinge x1 ball bearing hinge x1	better performance using hydraulic hinge x2
≤60kgs	≤2000x900mm	hydraulic hinge x2	door height over 2100mm, add a ball bearing hinge in the middle.
≤90kgs	≤2400x1100mm	hydraulic hinge x3	

H635 H-Type Hydraulic Hinge



Determine Direction

Check the hinge open direction matches with the door.

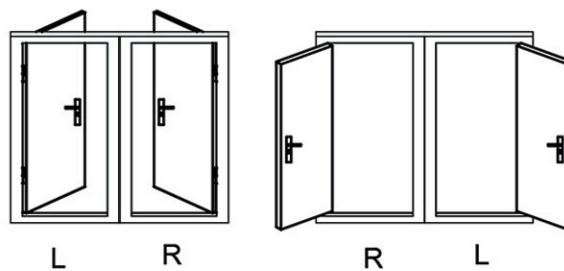

Dimensions 6"

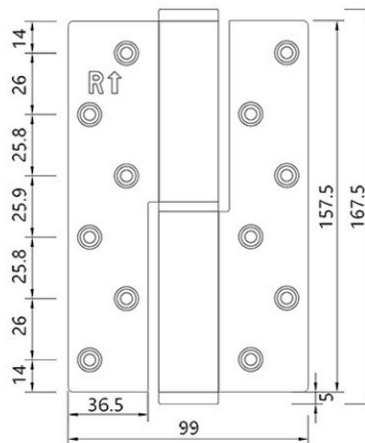

Specification

Door Weight	Door Size	Hinges	Remarks
≤50kgs	≤2000x700mm	hydraulic hinge x1 ball bearing hinge x1	better performance using hydraulic hinge x2
≤90kgs	≤2000x900mm	hydraulic hinge x2	door height over 2100mm, add a ball bearing hinge in the middle.
≤135kgs	≤2400x1100mm	hydraulic hinge x3	



H635P H-Type Hydraulic Hinge (surface mounting)



Determine Direction

Check the hinge open direction matches with the door.

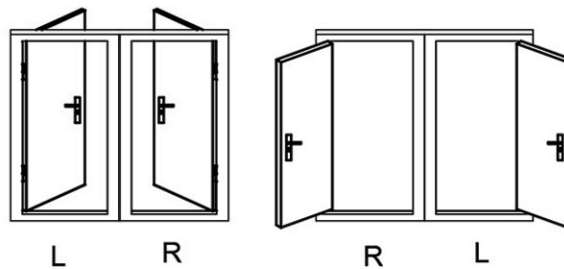

Dimensions 6"

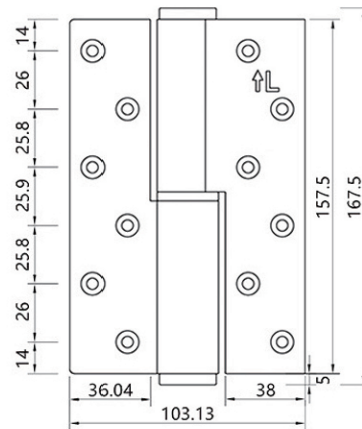

Specification

Door Weight	Door Size	Hinges	Remarks
≤50kgs	≤2000x700mm	hydraulic hinge x1 ball bearing hinge x1	better performance using hydraulic hinge x2
≤90kgs	≤2000x900mm	hydraulic hinge x2	door height over 2100mm, add a ball bearing hinge in the middle.
≤135kgs	≤2400x1100mm	hydraulic hinge x3	

BK7 Glass Door Hydraulic Hinge (K slot)



Determine Direction

Check the hinge open direction matches with the door.

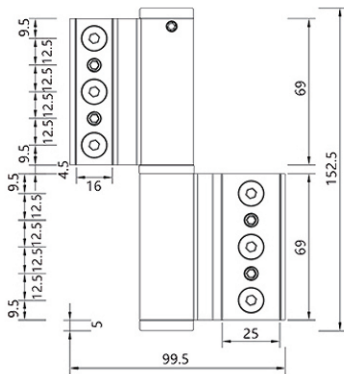
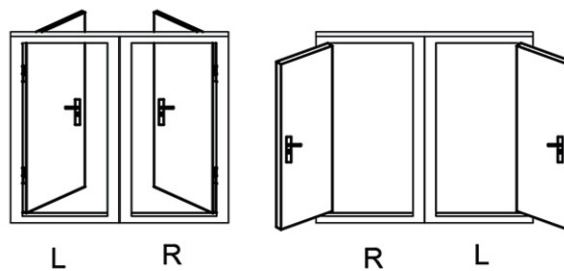

Installation

Refer to the opening direction selection diagram to distinguish left/right hinges according to parent R/L.

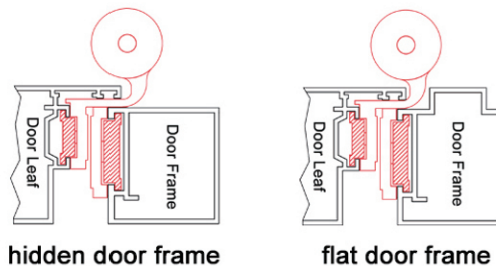

Specification

Door Weight	Door Size	Hinges	Remarks
≤35kgs	≤2000x700mm	hydraulic hinge x1 ball bearing hinge x1	better performance using hydraulic hinge x2
≤60kgs	≤2000x900mm	hydraulic hinge x2	door height over 2100mm, add a ball bearing hinge in the middle.
≤90kgs	≤2400x1100mm	hydraulic hinge x3	



BE7 Glass Door Hydraulic Hinge (European standard)



Determine Direction

Check the hinge open direction matches with the door.

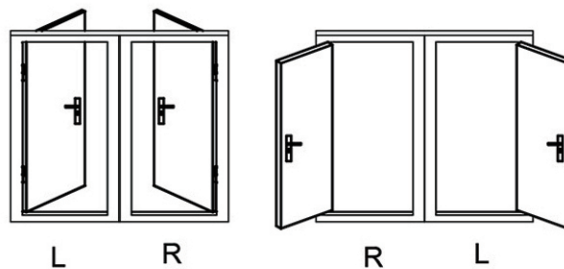

Installation

Refer to the opening direction selection diagram to distinguish left/right hinges according to parent R/L.

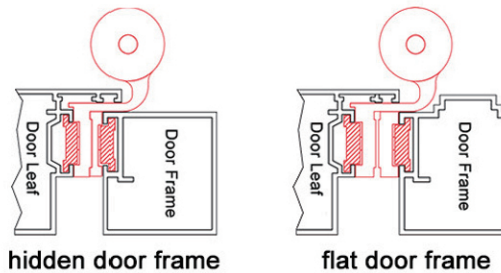
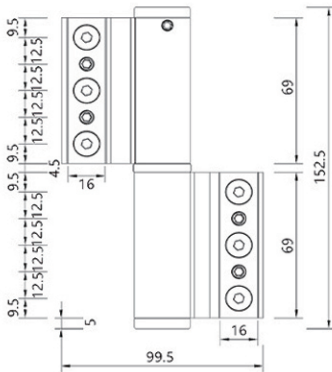

Specification

Door Weight	Door Size	Hinges	Remarks
≤35kgs	≤2000x700mm	hydraulic hinge x1 ball bearing hinge x1	better performance using hydraulic hinge x2
≤60kgs	≤2000x900mm	hydraulic hinge x2	door height over 2100mm, add a ball bearing hinge in the middle.
≤90kgs	≤2400x1100mm	hydraulic hinge x3	

G6 Glass Door Hydraulic Hinge

(for partition glass door)



Determine Direction

Check the hinge open direction matches with the door.

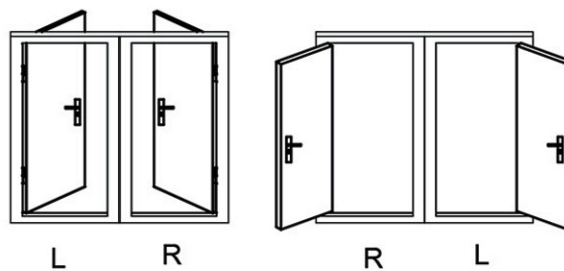

Dimensions

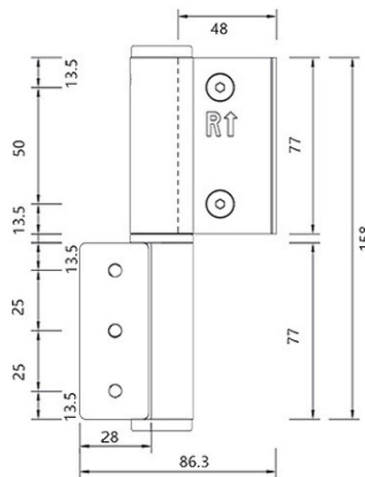

Specification

Door Weight	Door Size	Hinges	Remarks
≤50kgs	≤2000x700mm	hydraulic hinge x1 ball bearing hinge x1	better performance using hydraulic hinge x2
≤90kgs	≤2000x900mm	hydraulic hinge x2	door height over 2100mm, add a ball bearing hinge in the middle.
≤135kgs	≤2400x1100mm	hydraulic hinge x3	



Concealed Door Hinge

*Invisible after door closing.
Minimalist design to fit simplicity space.*

Material: Aluminum alloy

Thickness: 2mm

Finish:  black  grey  gold  silver and others.

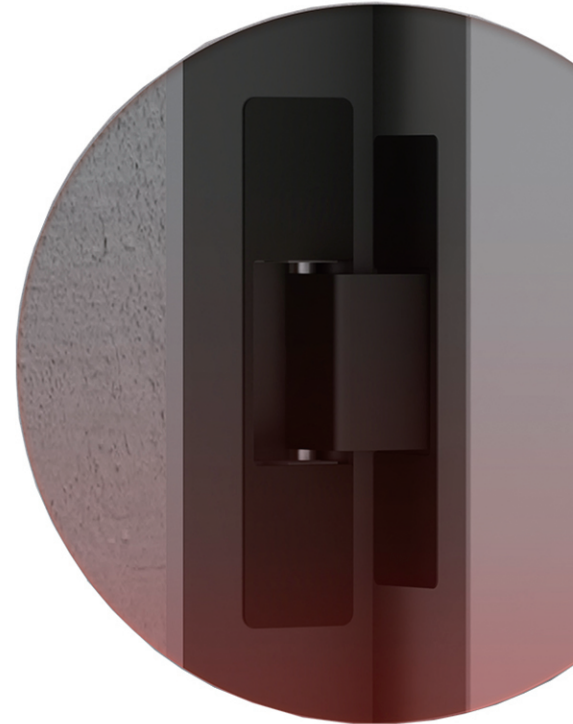

Applications

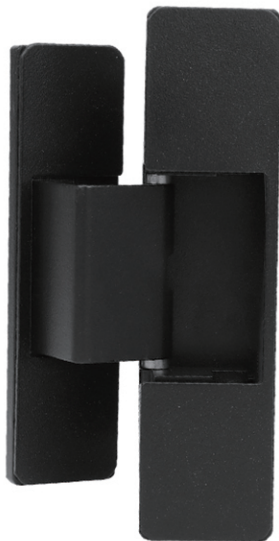

Wood Door
(adjustable directions)

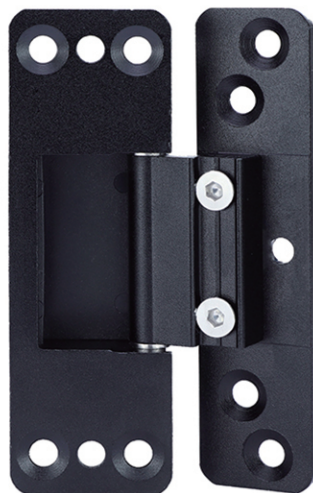

Glass Door
(detachable hinges)



Glass Door
(heavy-duty, narrow frame)

CWD114 Concealed Door Hinge

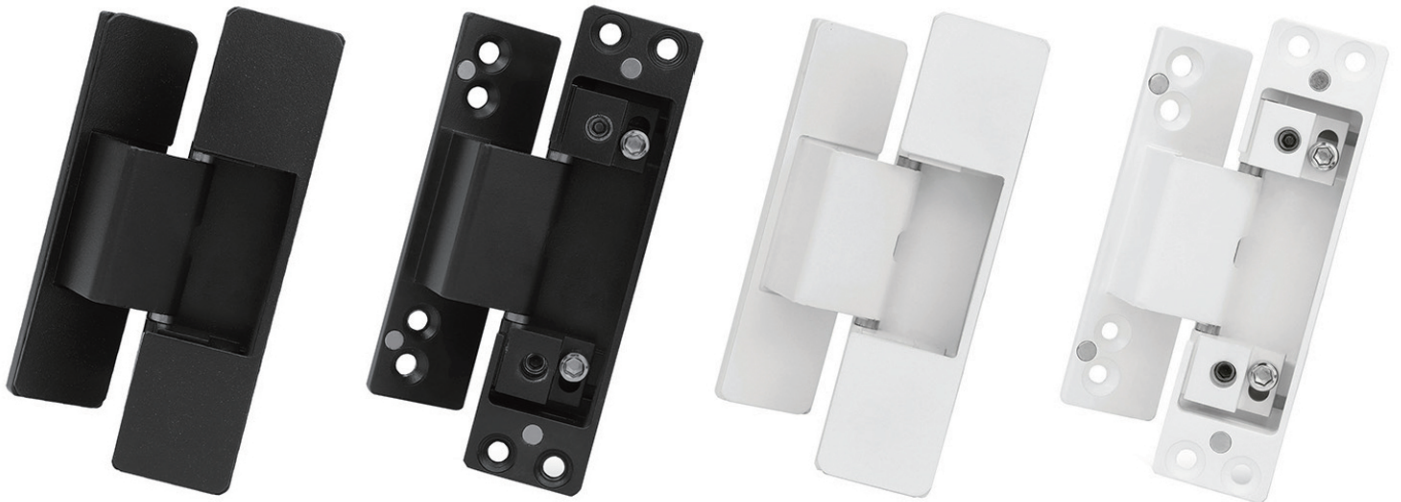

General Information

- Wood door use.
- Max. loading of door weight: 22kgs.
- Max. door opening 110°.
- Available finishes.
- Adjustable hinge either up/down, and forward/backward in case the wood door is misaligned after use for a while.



Installation View

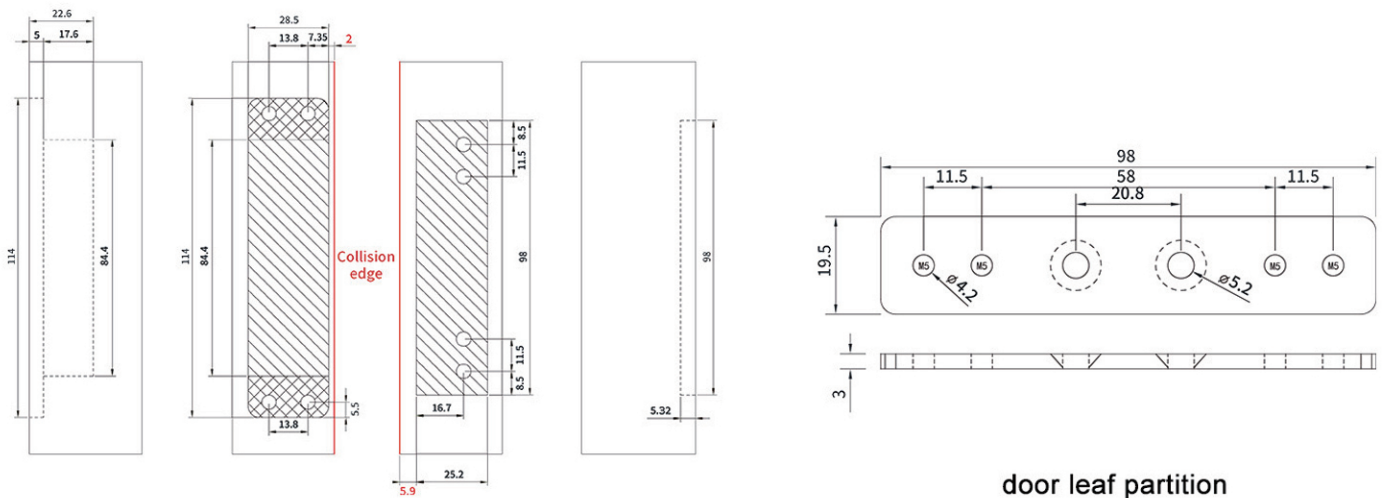

3597 Concealed Door Hinge

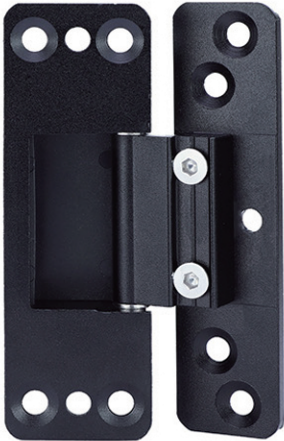

General Information

- Glass door use.
- Max. loading of door weight: 22kgs.
- Max. door opening 110°.
- Door thickness: 35, 40, 45mm

- Detachable hinges.
- Available finishes.



Dimensions

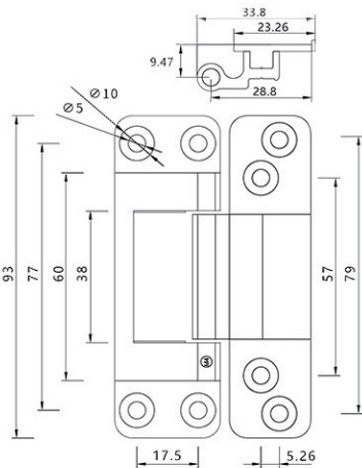

for 35mm frame

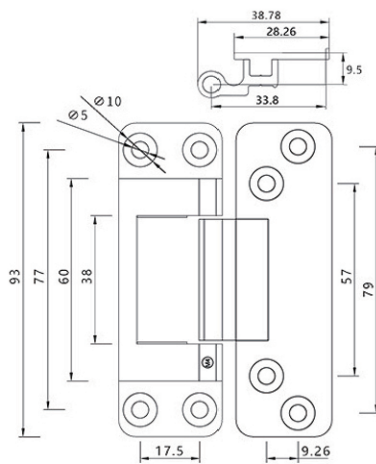

for 40mm frame

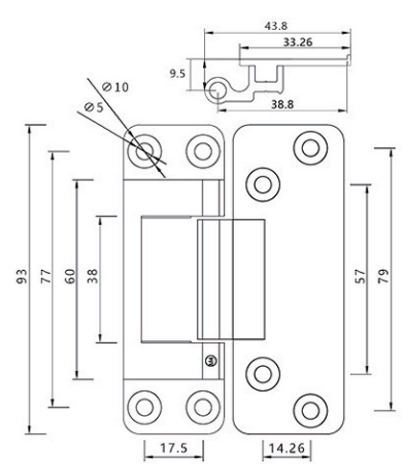

for 45mm frame

4583 Concealed Door Hinge



General Information

- Glass door use.
- Narrow hinge.
- Heavy-duty loading of door weight: 25kgs.
- Max. door opening 110°.
- Door thickness: 35, 40, 45mm
- Available finishes.



Dimensions

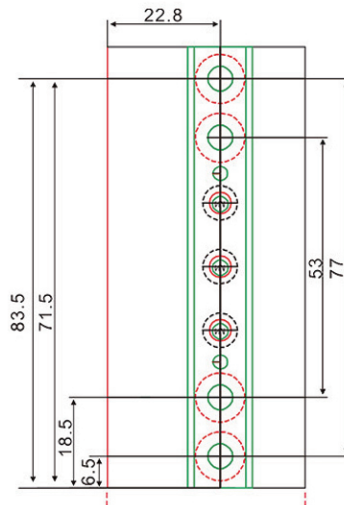

Installation

Using a positioning jig for drilling holes according to the door thickness 35, 40, or 45mm.

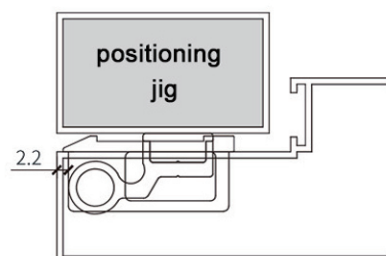





BSI Security Co., Ltd

✉ sales@bsi-hardware.com

🌐 www.bsi-hardware.com